

Straight Bit, 12 x 31.8 x 8 x 32 mm

D-13524

Straight Bit, 12 mm

12 x 31.8 x 8 x 32 mm

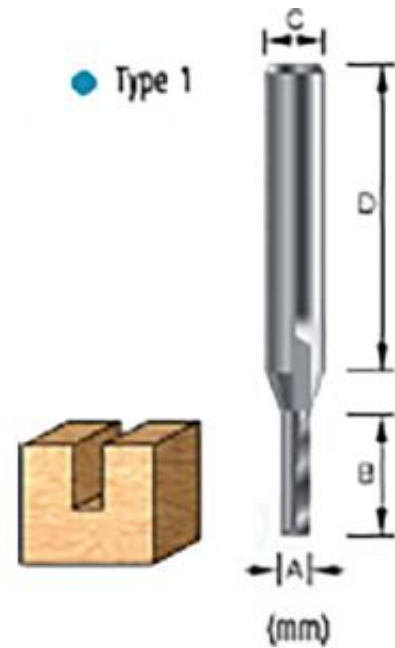

TECHNICAL SPECIFICATIONS

Diameter (D)	12 mm
Length	32 mm
Width A	8 mm
Shank (C)	31,8

